



Zoe



SANREMO
COFFEEMACHINES

made in italy

COLORED AND VERSATILE
Totally matching every type of decorative solution thanks to the possible customizations

SED VERSION
Guarantees an electronic dosing system through the button panel



COMPLETE RANGE
Available versions: SED and SAP, 1-2-3 group, Tall and Compact

SAP VERSION
Allows the semi-automatic programming of doses



EASY SERVICE
Fast access to the internal parts for quick and easy technical service

LOW SERVICE COST
Designed to decrease the maintenance and inspection costs

Characteristics

ELECTRONIC AUTO-LEVEL
Through an electronic level probe the boiler is automatically filled and maintained to the right filling level.

ACTIVATED ELECTRONIC PRE-INFUSION
Management of the delayed activation of water solenoid in the first phase of brewing.

DOUBLE READING GAUGE
Allows to control at the same time the boiler pressure and the distribution pressure.

EASY SERVICE
Fast access to the internal parts for quick and easy technical service.

AUTOMATIC CLEANING CYCLE
Process for coffee groups cleaning.

Optional

AUTOSTEAM
Steam wand characterized by an electronic system that allows to mount and/or heat milk at the set temperature.

CUP WARMER
Dedicated resistor to keep all the cups at the optimal temperature.

EXTERNAL VOLUMETRIC PUMP **BLUETOOTH COMMUNICATION SYSTEM** **NAKED PORTAFILTERS**

Versions

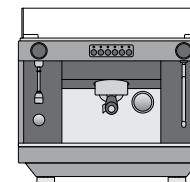

20.87 inches / 530 mm

1 group SED/SAP
1 steam tap
1 water tap
1 one-cup portafilters
1 two-cup portafilters

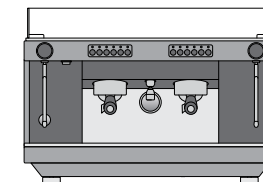

28.35 inches / 720 mm

2 group SED/SAP
2 steam taps
1 water tap
1 one-cup portafilters
2 two-cup portafilters

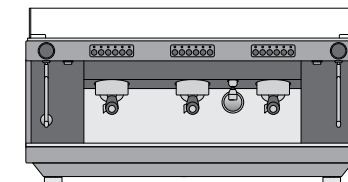

37.40 inches / 950 mm

3 group SED/SAP
2 steam taps
1 water tap
1 one-cup portafilters
3 two-cup portafilters

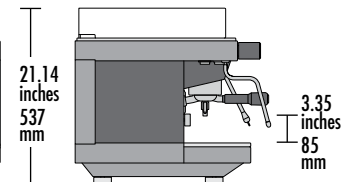

21.14 inches / 537 mm

3.35 inches / 85 mm

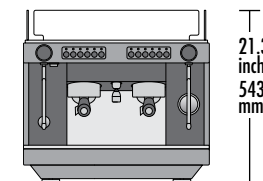

20.87 inches / 530 mm

COMPACT VERSION
2 group
2 steam taps
1 water tap
1 one-cup portafilters
2 two-cup portafilters

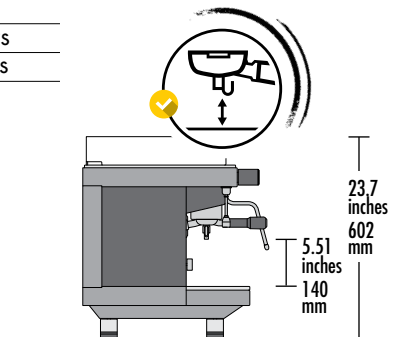

21.38 inches / 543 mm

23.7 inches / 602 mm
5.51 inches / 140 mm

TALL VERSION
2-3 group
SED
SAP

Technical data

		1 group	2 group	3 group	compact
voltage	V		220-240 1N / 380-415 3N		
power input	kW	2.3	3.3	6	2.7
steam boiler capacity	US gal / lt	1.19 / 4.5	2.64 / 10	3.7 / 14	1.85 / 7
steam boiler power	kW	2.15	2.95	5.6	2.5
pump power	kW	0.13	0.13	0.13	0.13
net weight	lb / kg	90 / 41	121 / 55	152 / 69	99 / 45

Colors

	Black	RAL 9005
	White Black	RAL 9003 9005
	White Matte black	RAL 9003 9005
	White Red	RAL 9003 3002

PERSONALISED GRAPHICS

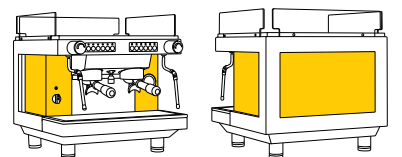

Zoe
Link to the website

Customization of internal panels with graphics and colors (on request).



*For more information about our
coffee machines please contact us
at export@sanremomachines.com*



SANREMO
COFFEE MACHINES

SANREMO coffee machines s.r.l.
Via Giacomo Bortolan 52
31050 Vascon di Carbonera [TV] – ITALY
T +39 0422 448900
F +39 0422 448935
www.sanremomachines.com